

PRIMO LED Canopy Light



Areas of application

- Gas station
- Warehouse
- Logistic hall
- Toll station
- Exhibition center
- Workshop

**5 YEAR
WARRANTY**

Product Benefits

- Up to 100,000hrs @ L70, low maintenance cost
- World class, approbated quality components (LEDs /Driver /etc.)
- Tempered glass cover, easy for cleaning
- Compact die-cast structure, solid mechanism and reliable quality
- Atex certification allows the lamps to be used safely in flammable and explosive areas
- Optional installations accessories for recessed, surface and bracket mounting
- 5 years warranty

Product Features

- Luminaire efficacy: Up to 165 lm /w
- Lifetime more than 100, 000 hours
- Impact resistance: IK10
- Type of protection: IP66



Product Datasheet

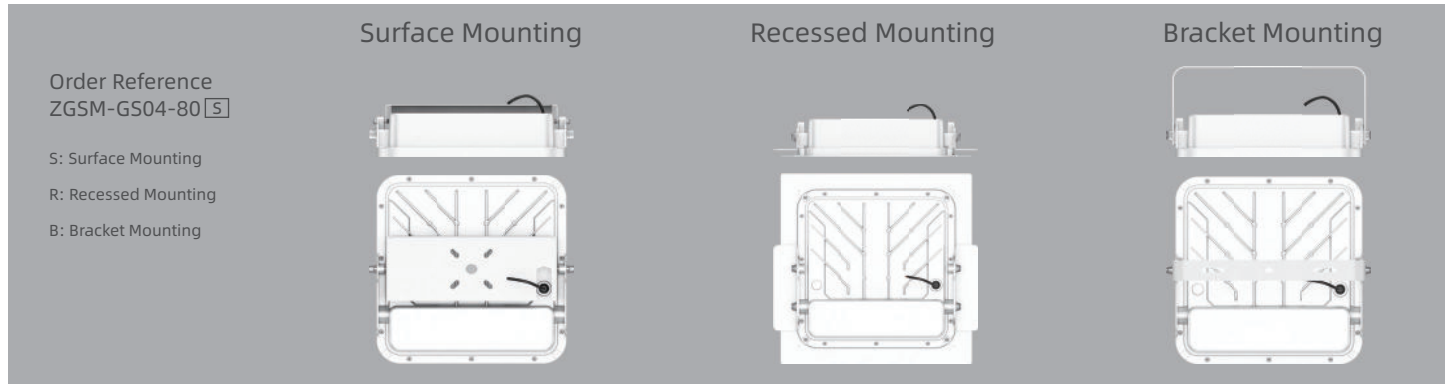

Electrical Data:

Model No	ZGSM-GS04-80 □	ZGSM-GS04-100 □	ZGSM-GS04-120 □	ZGSM-GS04-150 □
Nominal Wattage	80W	100W	120W	150W
Efficiency(±5%)	165 lm /w	160 lm /w	160 lm /w	155 lm /w
Lumen(±5%)	13200 lm	16000 lm	19200 lm	23250 lm
Nominal Voltage	AC 100-240V /277V 50 /60Hz			
LED	Philips Lumileds			
Driver	Inventronics (Default) /Other brands on request			
Power Factor (PF)	>0.95			
THD	<15			
SPD	10KV (Build-in Driver) /Extra 10KV SPD (Available on request)			
Optics	60°, 90° or 120°			
Standard Deviation of Color Matching	<5 SDCM			
CRI	Ra>70 (Default) /Ra>80			
CCT	3000K, 4000K, 5000K, 5700K			

*Above values are calculated based on the product with CCT over 3000K, values of 3000K are 5% lower than above values.

General Data

Body Material	High pressure die-cast aluminum
Housing Color	White
Cover Material	Tempered glass
Lens Material	UV-resistant Polycarbonate
Working Environment	-40°C ~ +50°C, 10% ~90%RH
Lifespan L70 at 25 °C	>100, 000 h
Mounting Type	Surface mounting /Recessed mounting /Bracket mounting
Mounting Location	Wall /Ceiling
Dimmable	1-10V Dimming (Default) /Timer Dimming
Protection Class	Class I (Default) /Class II
Standards	CE, RoHS, CB, LM79, LM80, TM-21, ATEX, IP66, IK10
Available on request	Motion sensor, NTC, OLC, DALI Dimming

Product Datasheet

Product Dimensions:

Surface Mounting

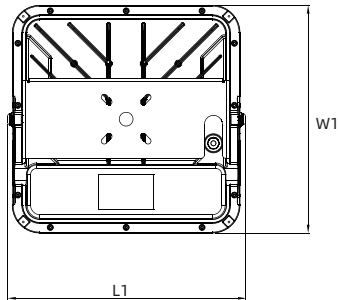

Recessed Mounting

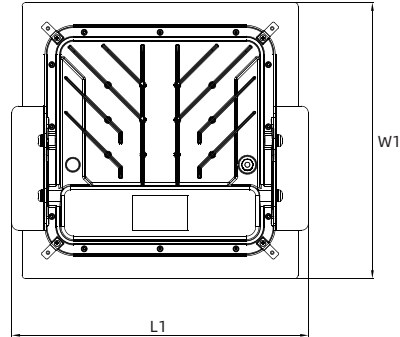
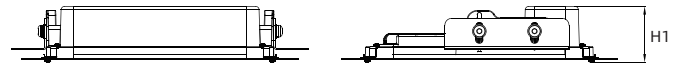

Bracket Mounting

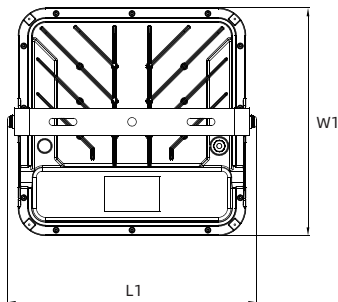
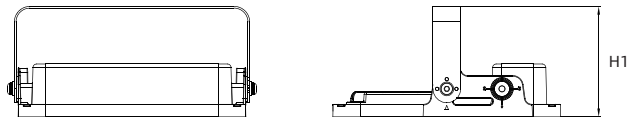

Version	L1 xW1 xH1	Weight
Surface Mounting	346 x330 x92mm	4.3kg
Recessed Mounting	430 x400 x79mm	4.7kg
Bracket Mounting	361 x330 x160mm	4.0kg

Packing Information:

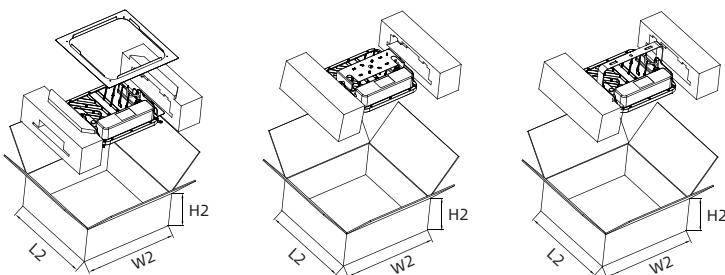

Version	L2 xW2 xH2	Weight
Surface Mounting	380 x380 x150mm	4.9kg
Recessed Mounting	425 x425 x145mm	5.6kg
Bracket Mounting	380 x380 x150mm	4.6kg

Product Datasheet

Light Distributions

Order reference

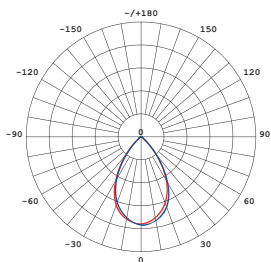
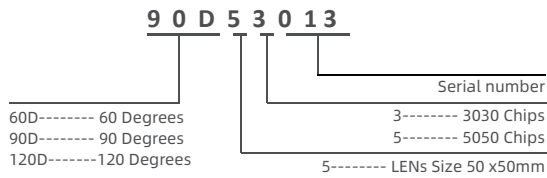

60D53012

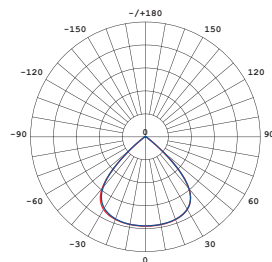

90D53013

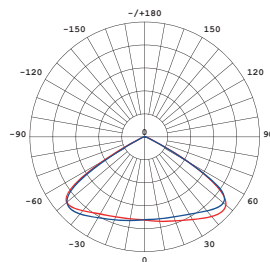

120D53014

Installation

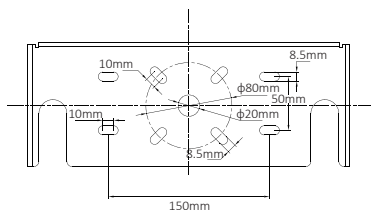

Surface Mounting

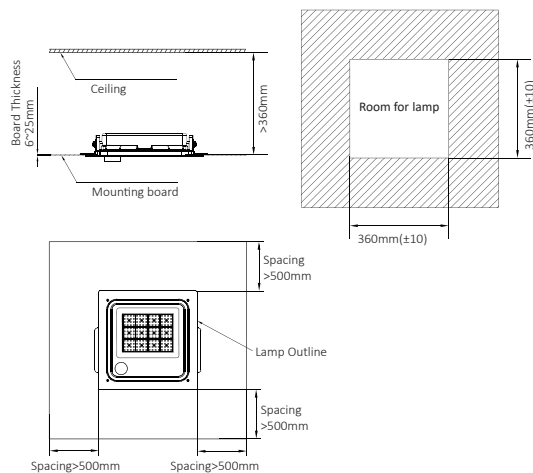

Recessed Mounting

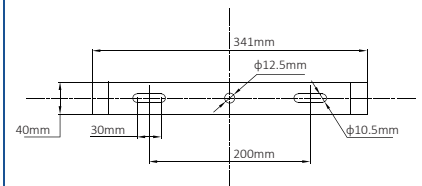

Bracket Mounting

Optional accessories

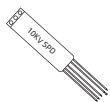

Extra 10KV SPD

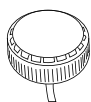

Motion Sensor

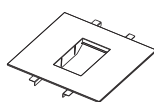

Customized frame