

L -SERIES



SAVE TODAY'S ENERGY FOR TOMORROW



ISO9001
ISO14001



CE CB

RoHS
Compliant



IP66
IK08

LM-80

5 YEAR
WARRANTY

LED URBAN LIGHT



LED power supply



+ NON-DIMMABLE

High-end MeanWell HLG Series LED driver, optimal stability, performance and lifespan.



+ DIMMABLE

High-end programmable Inventronics LED driver, integrate dimming function and 6KV /10KV surge protection. Provide excellent performance and lifespan.

High-efficacy LED light source



Philips Lumileds 3030 2D
Greater than 165lm/W high efficacy, illumination grade LED light source.

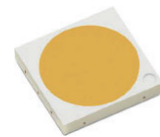

Philips Lumileds 5050
Greater than 185lm/W high efficacy, illumination grade LED light source.



Imported breather

Lamp breather ensures air balance inside and outside of the lamp, which improves lamp's service life.

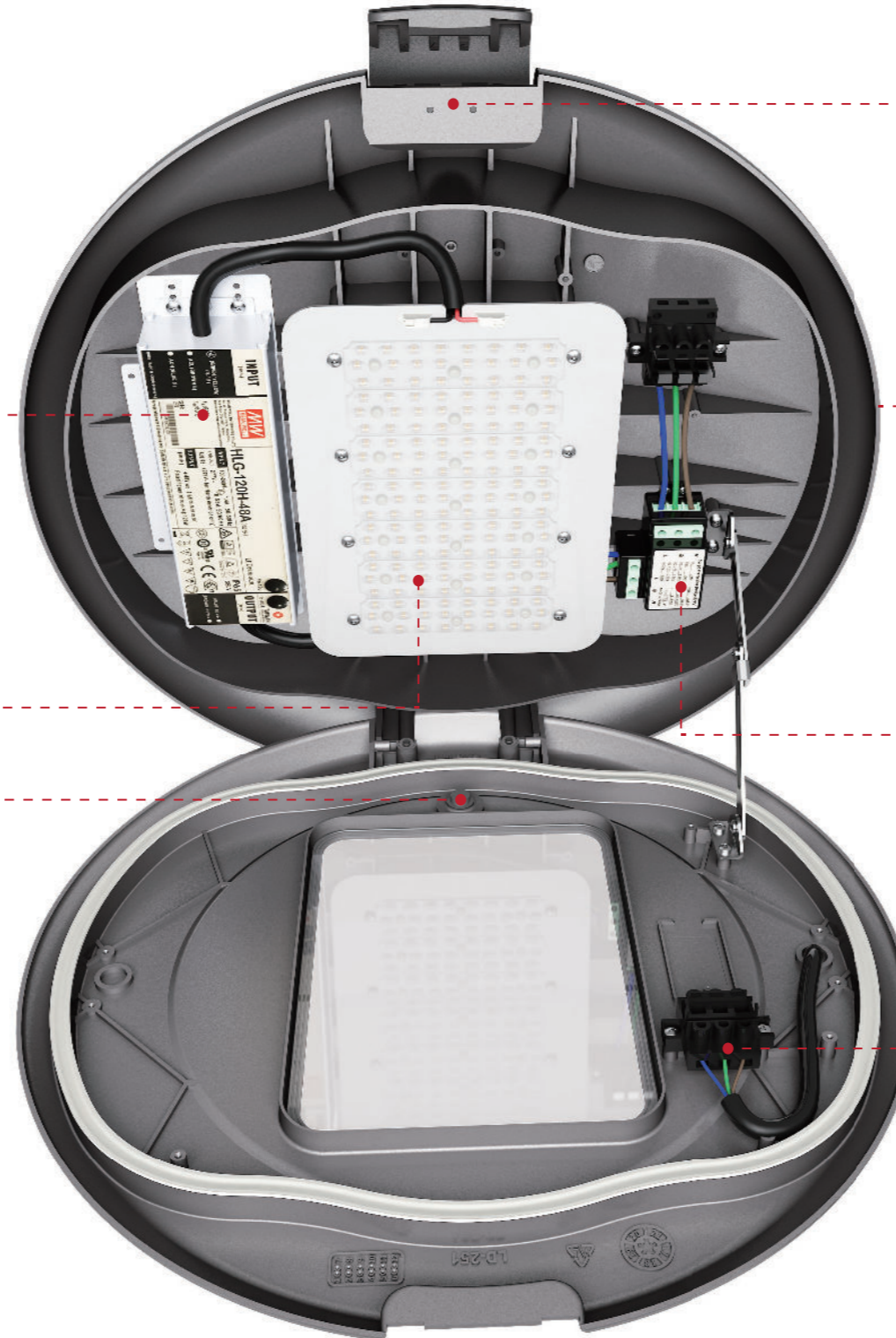

Easy Maintenance

Tool-less quick-release latches for speedy access.



Photocell available

Lamp will Auto turn on and off according to lux difference.



Surge protection device(10KV)

To provide more reliable guarantee for LED driver, extend the life of the product.



Power turn off protector

Under maintenance, when the fixtures be opened, the power will be cut off to protect personal safety.

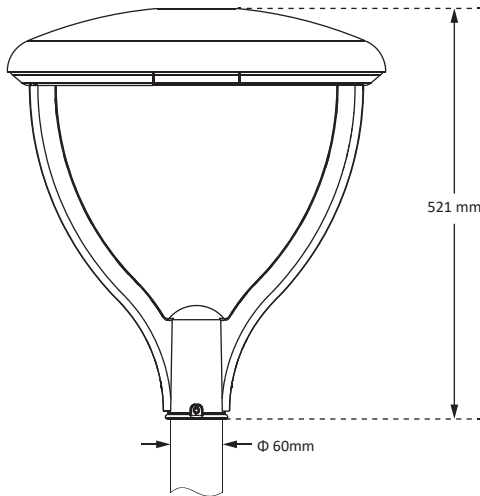
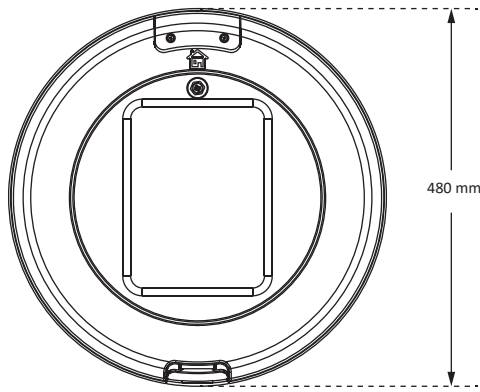

Post Top Mounted

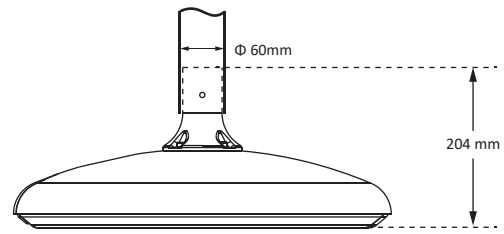

Pendant Mounted

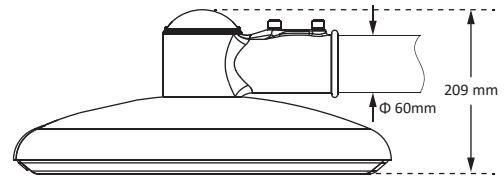

Side Entry Mounted

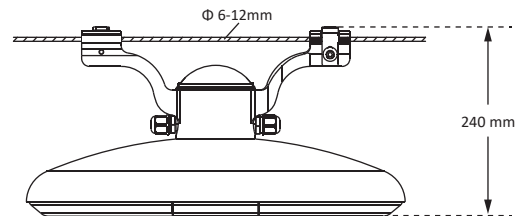

Suspended Mounted

Packing Details

★ Luminaire [Side Entry Mounted and Suspended Mounted]

Model	Carton Size (mm)	N.W (kg)	G.W (kg)
ZGSM-LD27LM	495*495*170	7.5	8.8
ZGSM-LD37LM	495*495*170	7.5	8.8
ZGSM-LD56LM	495*495*170	7.5	8.8
ZGSM-LD70LM	495*495*170	7.7	9.0
ZGSM-LD90LM	495*495*170	7.9	9.2
ZGSM-LD120LM	495*495*170	8.0	9.3

Note: Above data of weight are all typical values.

★ Accessories [Side Entry Mounted and Suspended Mounted]

Mounted Type	Carton Size (mm)	N.W (kg)	G.W (kg)
Side Entry Mounted	235*125*105	1.1	1.2
Suspended Mounted	355*150*105	0.9	1.0

Note: Above data of weight are all typical values.

★ Luminaire and Accessories [Post Top Mounted and Pendant Mounted]

Model	Carton Size (mm)	Post Top Mounted		Pendant Mounted	
		N.W(kg)	G.W(kg)	N.W(kg)	G.W(kg)
ZGSM-LD27LM	495*495*170	8.8	10.1	7.8	9.1
ZGSM-LD37LM	495*495*170	8.8	10.1	7.8	9.1
ZGSM-LD56LM	495*495*170	8.8	10.1	7.8	9.1
ZGSM-LD70LM	495*495*170	8.9	10.2	8.9	9.2
ZGSM-LD90LM	495*495*170	9.2	10.5	9.2	10.5
ZGSM-LD120LM	495*495*170	9.2	10.5	9.2	10.5

Note: Above data of weight are all typical values.

Electrical & Photometric

A: Post Top Mounted

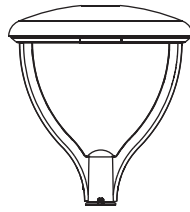

B: Pendant Mounted

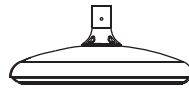

C: Side Entry Mounted

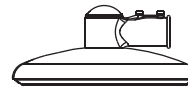

D: Suspended Mounted

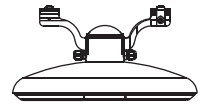

Order Reference
ZGSM-LD120LM A

★ 3030 Version

Series	Model	LED Qty/ Current	Power	Luminaire efficacy (+/- 5%)	Lumen Output (+/- 5%)	Input Voltage	LED Brand	Driver Brand	Light Distributions	CCT (K)	Surge Protection Device	Lifetime (h)
L	ZGSM-LD27LM □	72units/ 56mA	27W	130 lm /w*1	3510 lm	100-240V /277V AC 50 /60Hz	Philips Lumileds 3030 2D	MeanWell Inventronics	1M, 2M, 2M BLS, 3M, 5S*2, 1M Symmetry	3000*3 4000 5000 5700	10KV	>100,000 (L70)
	ZGSM-LD37LM □	96units/ 59mA	37W	130 lm /w*1	4810 lm							
	ZGSM-LD56LM □	120units/ 70mA	56W	130 lm /w*1	7280 lm							
	ZGSM-LD70LM □	144units/ 78mA	70W	130 lm /w*1	9100 lm							
	ZGSM-LD90LM □	168units/ 86mA	90W	130 lm /w*1	11700 lm							
	ZGSM-LD120LM □	168units/ 110mA	120W	125 lm /w*1	15000 lm							

*1 Luminous Efficacy of post top mounted is 10% lower than other installation methods.

*2 Luminous Efficacy of 5S is 15% higher than other Light Distributions.

*3 Luminous Efficacy of 3000K is 5% lower than other CCTs.

★ 5050 Version

Series	Model	LED Qty/ Current	Power	Luminaire efficacy (+/- 5%)	Lumen Output (+/- 5%)	Input Voltage	LED Brand	Driver Brand	Light Distributions	CCT (K)	Surge Protection Device	Lifetime (h)
L	ZGSM-LD27LM □	36units/ 28mA	27W	150 lm /w*1	4050 lm	100-240V /277V AC 50 /60Hz	Philips Lumileds 5050	MeanWell Inventronics	2M, 3M, 5S*2	3000*3 4000 5000 5700	10KV	>100,000 (L70)
	ZGSM-LD37LM □	48units/ 29mA	37W	150 lm /w*1	5550 lm							
	ZGSM-LD56LM □	60units/ 35mA	56W	150 lm /w*1	8400 lm							
	ZGSM-LD70LM □	72units/ 40mA	70W	150 lm /w*1	10500 lm							
	ZGSM-LD90LM □	84units/ 42mA	90W	150 lm /w*1	13500 lm							
	ZGSM-LD120LM □	84units/ 56mA	120W	145 lm /w*1	17400 lm							

*1 Luminous Efficacy of post top mounted is 10% lower than other installation methods.

*2 Luminous Efficacy of 5S is 15% higher than other Light Distributions.

*3 Luminous Efficacy of 3000K is 5% lower than other CCTs.

Mechanical

Model	Working Environment	Storage Temperature	Rating	CRI	Power Factor	Power Efficiency	Material	Pole/ Rope Diameter (mm)
ZGSM-LD27LM	-40 °C ~ +50 °C 10% ~ 90%RH	-40 °C ~ +50 °C	Class I IP66 IK08	>70	>0.95	>90%	Housing: Die-cast aluminum Lens: Tempered glass and PC	Side Entry Mounted: Φ 60mm(External diameter of the pole) Suspended Mounted: Φ 6-12mm(External diameter of the rope) Post Top Mounted: Φ 60mm(External diameter of the pole) Pendant Mounted: Φ 60mm(Internal diameter of the pole)
ZGSM-LD37LM								
ZGSM-LD56LM								
ZGSM-LD70LM								
ZGSM-LD90LM								
ZGSM-LD120LM								

Note: Above data of weight are all typical values.

Light Distributions

★ Pendant Mounted | Side Entry Mounted | Suspended Mounted

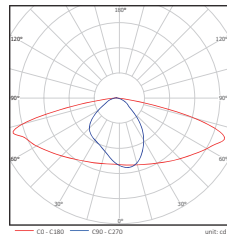
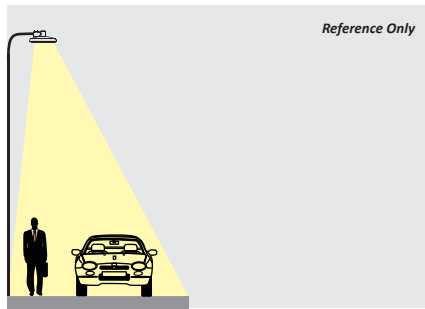

1M

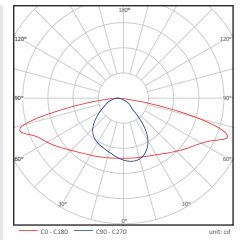
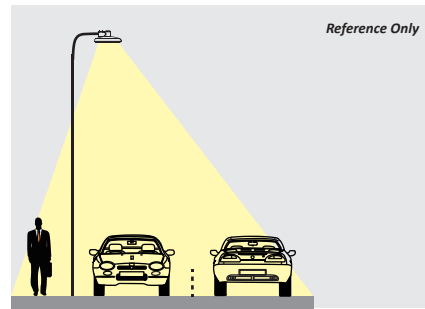

2M

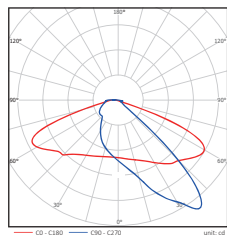
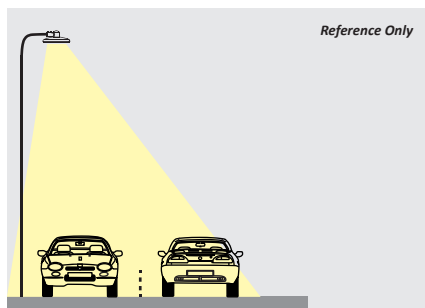

2M BLS

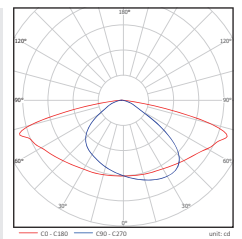
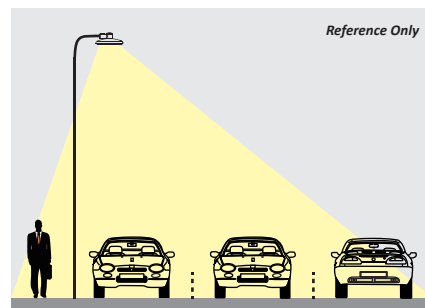

3M

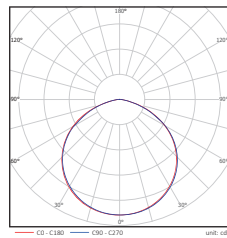
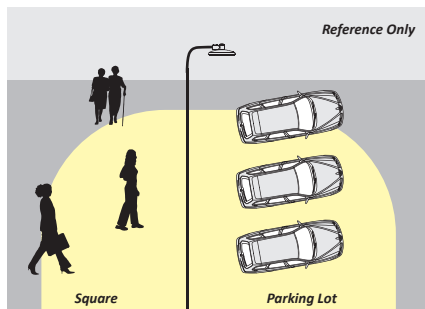

5S

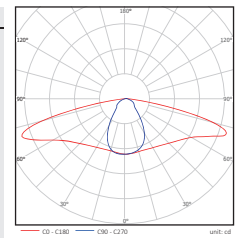
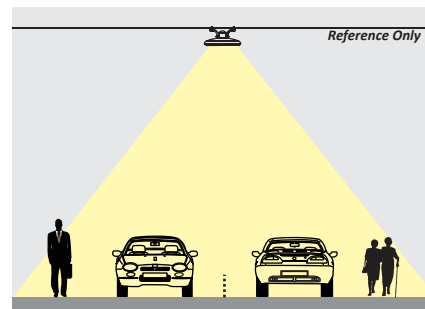

1M Symmetry

★ Post Top Mounted

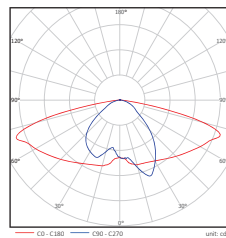
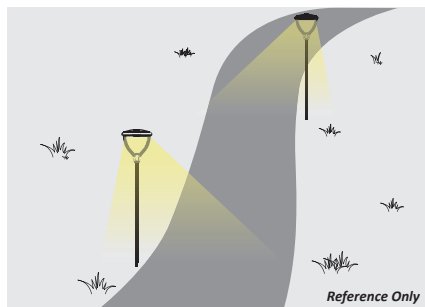

1M

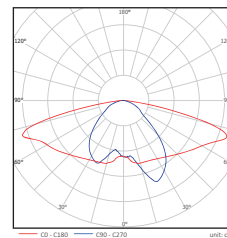

2M

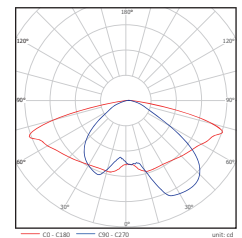

3M

Based on same mounting height, the lengthwise illumination area: 3M > 2M > 1M.

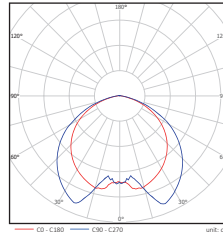
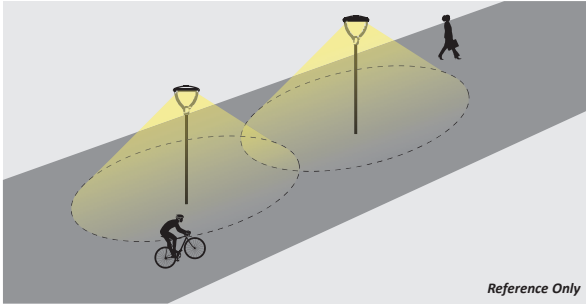

5S

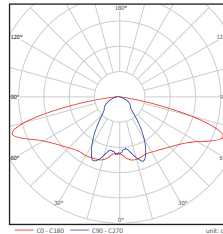
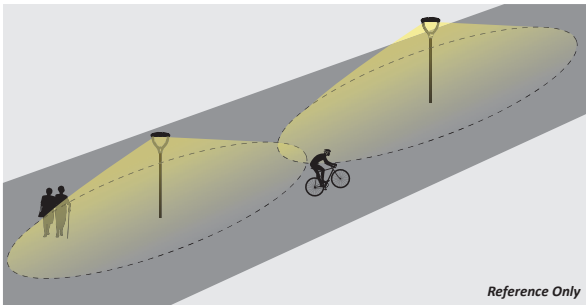

1M Symmetry

Optical Control

Optical control function is supported by optional

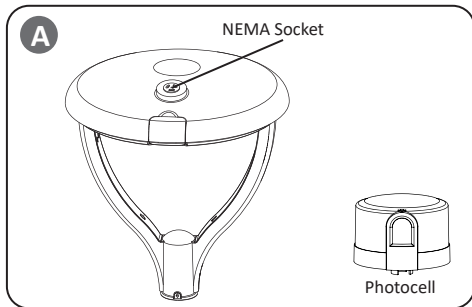

If the fixture with PHOTOCELL function, the NEMA Socket will be installed on the cover of fixture. See **A**. Fit the pins of Photocell to NEMA Socket, firmly insert and rotate Photocell to proper position.

<Verifying>

Make sure all the connections done and photocell is well installed on the fixture, switch on the power supply and cover the window of NEMA Socket, wait 5 seconds, the fixture will be turned on.

Certification

Manufacturer
ISO9001, ISO14001
L Series [ZGSM-LD27LM, ZGSM-LD37LM, ZGSM-LD56LM, ZGSM-LD70LM, ZGSM-LD90LM, ZGSM-LD120LM]
CE, CB, ROHS, ENEC, LM80

Intelligence Street Lighting System

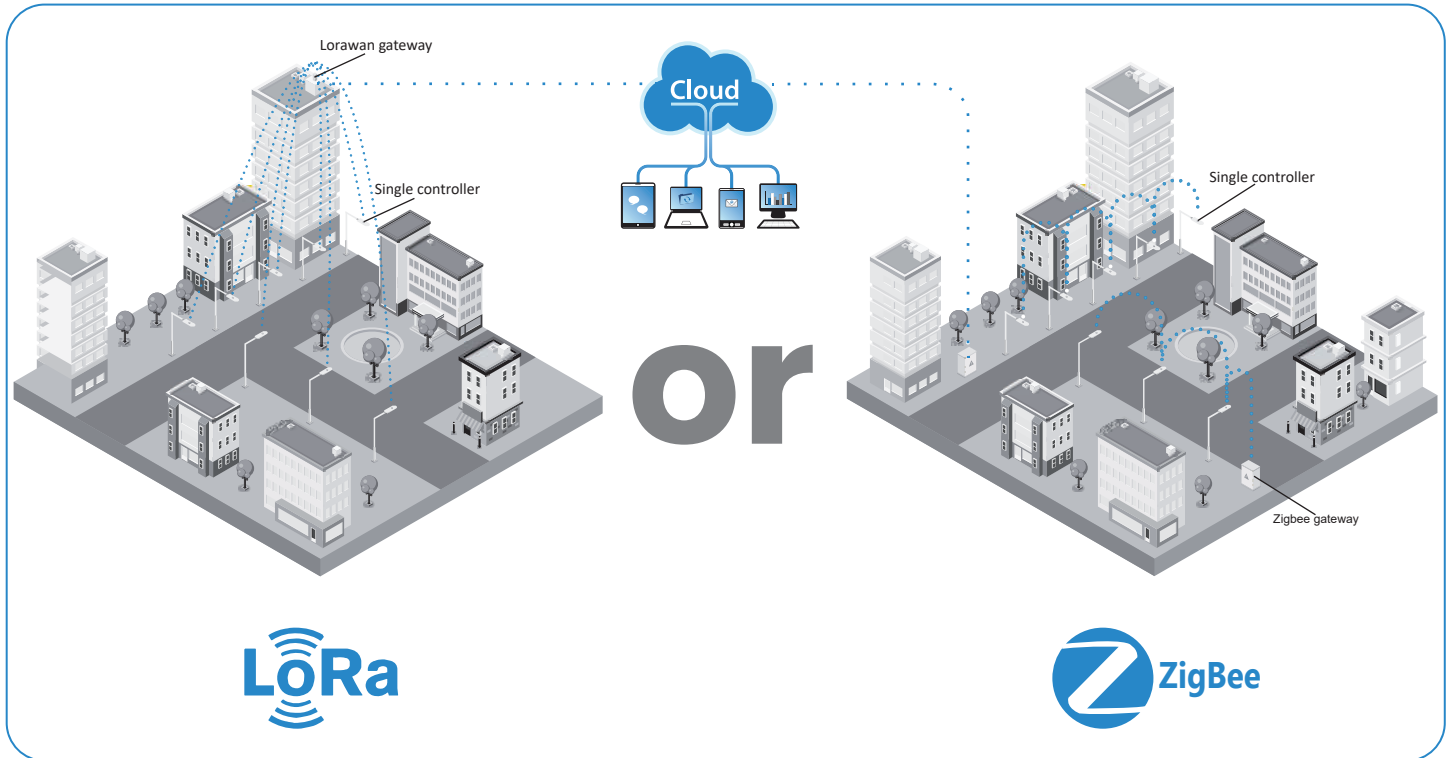

ZGSM provides a total solution for intelligence street lighting system.

ZGSM street light intelligence system is made up by software, gateway, single light controller. The gateway is installed in the distribution cabinet, the single light controller is installed in the lighting terminal. It proceeds with communication via GPRS/ CDMA/ WCDMA wireless network or cable network & monitor center and proceeds with communication via ZIGBEE/ LORA.

Gateway can control each single light controller via receiving, executing, forwarding PC management software, which can control each lamp's switching on/ off or dimming, then save electric energy. It can also monitor the lamps' electric energy to achieve failure lamps function. Gateway can built-in DO to achieve street light loop control, it can connect with other equipment to collect local illumination, temperature and other information, feedback to PC management software and achieve to monitor the current information.

At present, all our series of LED street lights can be combined with the intelligence street lighting system...

If you want to know more, please contact ZGSM Team.